



Calix Door-Mounted Heat Exchanger Installation Guide

July 2011

#220-00357 Rev. 13



Contents

Chapter 1: Installation Overview	5
Chapter 2: Preparing the Cabinet.....	7
Chapter 3: Installing the Heat Exchanger.....	11
Chapter 4: Connecting Power and Alarm Cables	13
Chapter 5: Testing the Installed Heat Exchanger	18



Installation Overview

Calix offers generic door-mounted heat exchanger kits for installing on any outdoor electronics enclosure that requires additional cooling capacity, including third-party enclosures or legacy Calix ODC cabinets (ODC-20, ODC-40, ODC-80). The heat exchanger uses a back-to-back fan arrangement with both internal and external loop intakes on the top and the exhaust on the bottom. The heat exchanger includes fully integrated temperature and alarm controllers.

Note: For the 1600W heat exchanger kit, the cabinet door to host the heat exchanger must accommodate an assembly size of 18.1" wide by 36.1" high, with a maximum protrusion of 8.8" from the surface of the door.

For the 300W heat exchanger kit, the cabinet door must accommodate an assembly size of 12" wide by 23" high, with a maximum protrusion of 4.8" from the surface of the door.

Heat exchanger kit contents

Before you begin the installation, verify that you have the following items:

Quantity	Description
1	Heat exchanger assembly, 1600 Watt or 300 Watt (options)
3	Drilling/cutting templates for the cabinet door (exterior, interior)
1	DC power jumper cable
1	Dual-feed (A/B) DC adapter, 12-inch (for legacy Calix ODC cabinets only)
1	Alarm jumper cable
6	Tie wraps, 5-5/8-inch (for cable dressing)
2	Cable clamp, 3/4-inch, screw mount nylon
2	7.5A fuses for DC distribution (high-power heat exchanger kit) <ul style="list-style-type: none"> • (1) GMT, 60V (black/white) • (1) FKS, 80V (dark brown)
2	5A fuses for DC distribution (low-power heat exchanger kit) <ul style="list-style-type: none"> • (1) GMT, 60V (green) • (1) FKS, 80V (light brown)
1	Wiring diagram, power for heat exchanger

User-Supplied Items

The following tools and materials are required to install the kit, but are not supplied by Calix:

- Jigsaw with metal-cutting blades
- Electric drill with magnetic drill bits, in 1/64" increments up to 3/8"
- Nut driver or socket wrench
- Allen wrench set
- Flat-blade screw driver
- Small crescent wrench
- Duct tape
- Cleaning towels
- Permanent marker
- Wire-wrap tool
- Tie-wrap cutter
- Metal files
- Metal paint

Notices

Complete the procedures in this guide in the order they appear.

Two people are required to lift and position the heat exchanger on a cabinet door and make initial attachments.



WARNING! This unit employs electrical voltage and amperage levels which, per GR-1089, may be considered an electrical hazard. Only qualified personnel should install, operate, maintain, or otherwise come in contact with this equipment when the panel is energized.

Preparing the Cabinet

This topic describes how to prepare the cabinet for installation of the door-mounted heat exchanger. This task includes cutting and modifying the cabinet door. Complete the steps below in the order they appear.

To prepare the cabinet for a door-mounted heat exchanger

1. Verify that all kit components and all required tools and materials are available and onsite at the cabinet location. (Refer to your packing slip and the list of kit contents and required tools in the previous section.)
2. Open the cabinet door that will host the door-mounted heat exchanger.

Note: For legacy Calix ODC cabinets, open the front door of the cabinet (right-front door on ODC-80).

3. If applicable, remove the laptop tray from the inner-door.

Note: On legacy Calix ODC cabinets, lower the laptop tray on the inner door, remove the two brackets that become revealed, and then remove the inner-door panel attaching hardware (16 places). Set aside the hardware for reuse.



4. **For legacy Calix ODC cabinets only:** Pull the inner-door panel away from the cabinet door, grasping with two hands, and then place it on the ground for modification.



5. Cover all the electronics equipment inside the cabinet with a plastic sheet or other protective material to avoid damage to the equipment.
6. Thoroughly clean both the interior and exterior of the cabinet door in preparation of affixing mounting templates to both surfaces.
7. Position the appropriate exterior mounting template on the outside of the cabinet door, following the instructions printed on the template. Use a level to ensure the cutout in the template is accurately placed. Tape the template in position on the cabinet door.

Note: For third-party cabinets, position the template according to the location of the heat exchanger inlet and outlet with reference to the installed equipment.



8. To clearly show the template's cutting areas, use a permanent marker to trace the inside of the (2) rectangular cutouts and the (12) drill holes in the template.

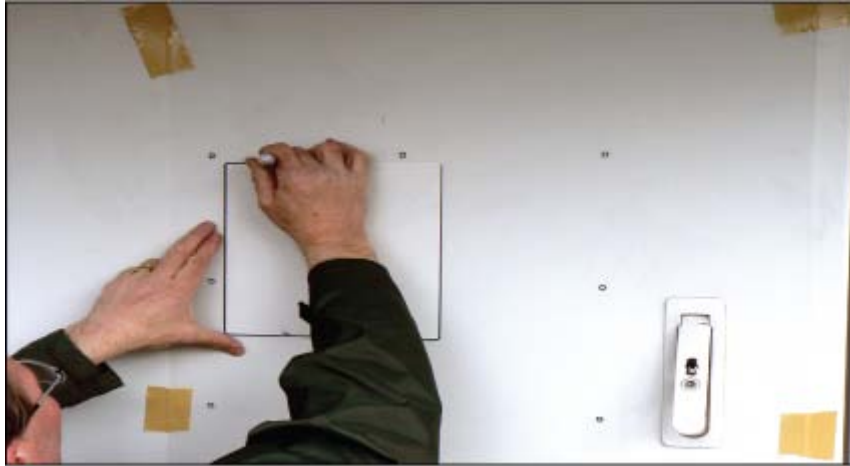

9. Position the interior mounting template on the inside of the door, using the bottom-left corner as a guide to accurately place the template. Tape the template in position.

Note: For legacy Calix ODC cabinets, position the interior template on the inner-door panel that you removed previously, as shown below.

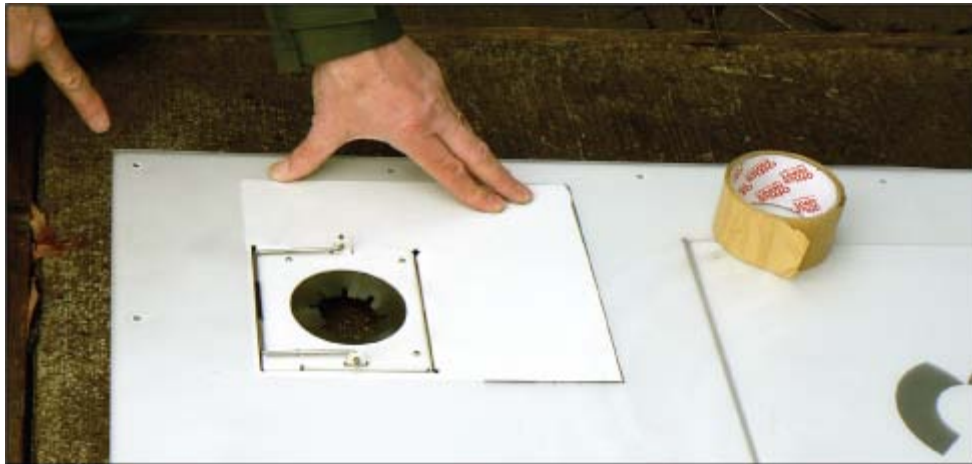

10. To clearly show the template's cutting areas, use a permanent marker to trace the inside of the (2) rectangular cutouts in the template.



11. To start the metal-cutting process, use a spring-loaded punch to create drill-locating divots in the four corners of each rectangular cutout and in the center of each of the (12) drill holes in the template on the exterior and interior of the cabinet door (or the inner-door panel, in the case of legacy ODC cabinets).



12. On the outside of the cabinet door, use progressively larger drill bits to drill through the (12) drill holes in the template, finishing at a 7/32-inch to 1/4-inch size.
13. Using a jigsaw with an approximately 36 TPR metal-cutting blade, cut around the inside of the rectangular areas in the template from the exterior of the cabinet door (and the inner-door panel, in the case of legacy ODC cabinets), leaving a small segment of material at each corner to help reduce vibration during the metal-cutting process.
14. Finish removing the cutaway material by completing the cuts around the corners.
15. Remove the templates from the door and smooth/de-burr the cut edges using a metal file.
16. Thoroughly clean and then paint the cut edges to protect against moisture (rust) damage. Alternatively, install the supplied grommet edging to all edges that remain available to human contact.

Installing the Heat Exchanger

This topic describes how to install the heat exchanger assembly on the modified cabinet door.

Note: Two people are required to lift and position the heat exchanger on a cabinet door and make initial attachments.

To install the heat exchanger on the cabinet door

1. Lift the heat exchanger assembly into position against the outside of the door. Hold the assembly in place while a second person attaches it to the cabinet door using the supplied hardware (12 places).

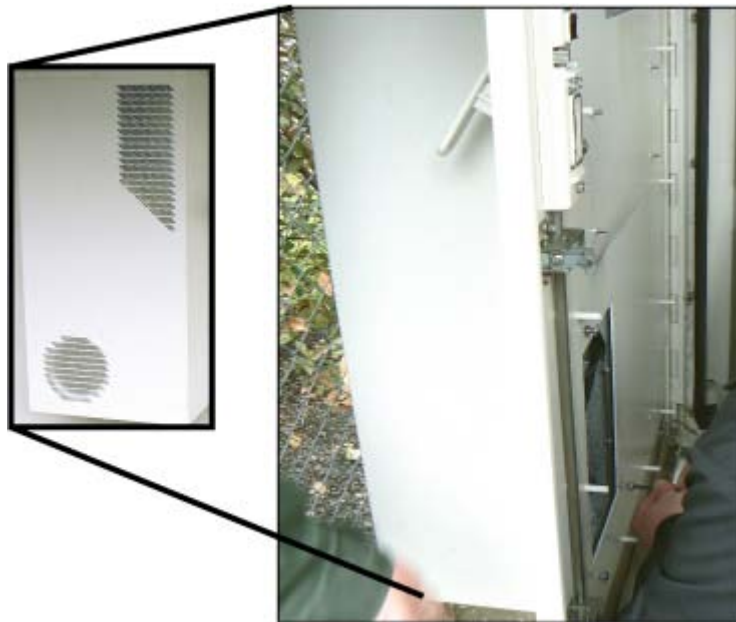

- 2. For legacy Calix ODC cabinets only:** Re-install the modified inner-door panel:
 - a. Attach the panel screws to the cabinet door (16 places).
 - b. Install the brackets and attaching hardware that you set aside previously.



- 3.** Remove any protective covering or material that you previously placed on the electronics equipment inside the cabinet, if applicable.

Connecting Power and Alarm Cables

This topic describes how to connect the heat exchanger power and alarm cables to the cabinet's power and alarm systems.



WARNING! This unit employs electrical voltage and amperage levels which, per GR-1089, may be considered an electrical hazard. Only qualified personnel should install, operate, maintain, or otherwise come in contact with this equipment when the panel is energized.

To connect the heat exchanger power cable

1. Take the power and alarm jumper cables from the kit packaging.
2. Locate the heat exchanger power and alarm interface cables, typically tucked inside the lower exhaust cavity.
3. Connect the supplied power jumper cable to the heat exchanger power interface cable (white connector).



4. Route the heat exchanger's power jumper cable to the cabinet's DC distribution system.
5. Check the termination type on the cabinet's DC distribution system, and then do one of the following:
 - If the distribution system uses wire-insertion terminals, clip off the cable's Molex connector, and then strip off 1/4-inch of insulation from the wire ends. The red wire is -48VDC and the black wire is Return.
 - If the distribution system uses ring-lug terminals, clip off the cable's Molex connector, and then crimp ring lugs onto the unterminated wire ends. The red wire is -48VDC and the black wire is Return.
 - For legacy Calix ODC cabinets, you can connect the power cable's Molex connector directly to the DC distribution board positions labeled **Spare** or **Test Head**, as shown below.

If both the **Spare** and **Test Head** locations are in use, you can use the supplied splitter cable to convert one of the unused C7 connections to an appropriate two-position connector.

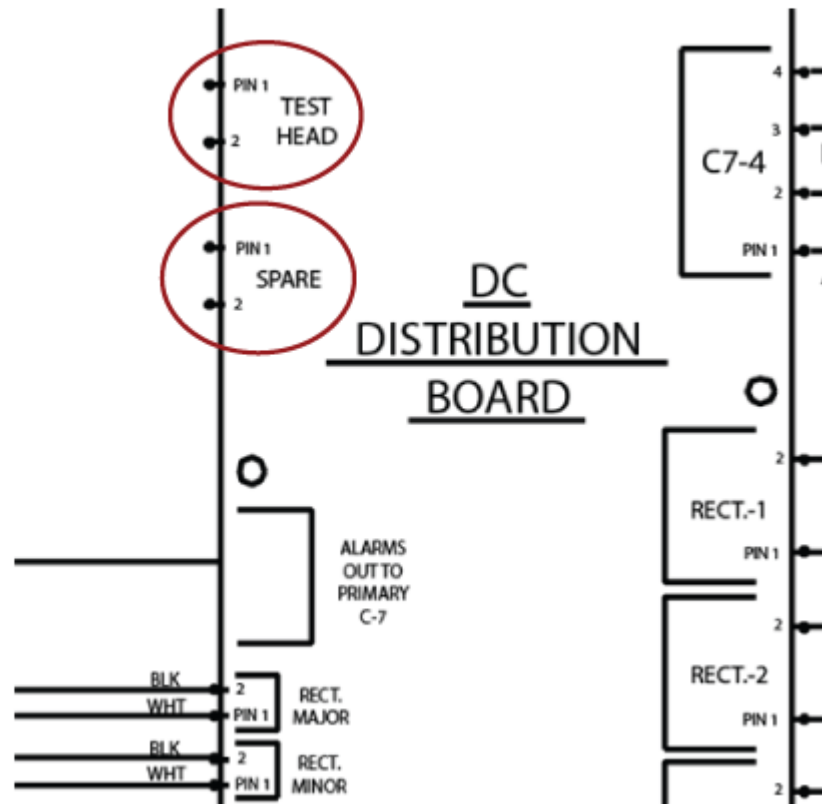

6. Insert the supplied 5A GMT fuse into the appropriate position on the cabinet's DC distribution system.

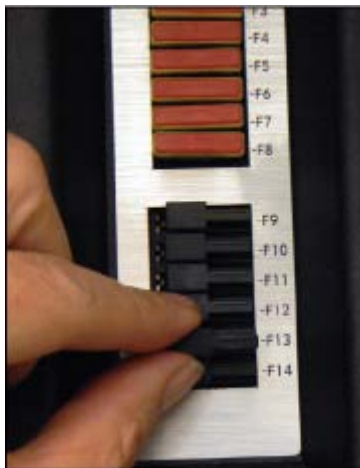

7. Use the supplied plastic cable clamps and tie wraps to dress and secure the power cable to the shelf.

To connect the heat exchange alarm cable (optional)

1. Connect the supplied alarm jumper cable to the heat exchanger alarm interface cable (red connector).



2. Route the alarm jumper cable to the primary equipment that reports alarms for the cabinet.
3. Terminate the alarm cable to the reporting equipment as required. Connect white to Ring and black to Tip.

Note: If the equipment terminating the heat exchanger alarm is a Calix C7, continue to Step 4 to wire the alarm interface to the C7. Otherwise, skip to *Testing the Installed Heat Exchanger* (on page [17](#)).

- 4. For legacy Calix ODC cabinets only:** Connect the heat exchanger alarm interface jumper to a Calix C7 as follows:
- Remove the right connector from the environmental alarm pin field on the AIM board, located on the rear of the C7 shelf, as shown.

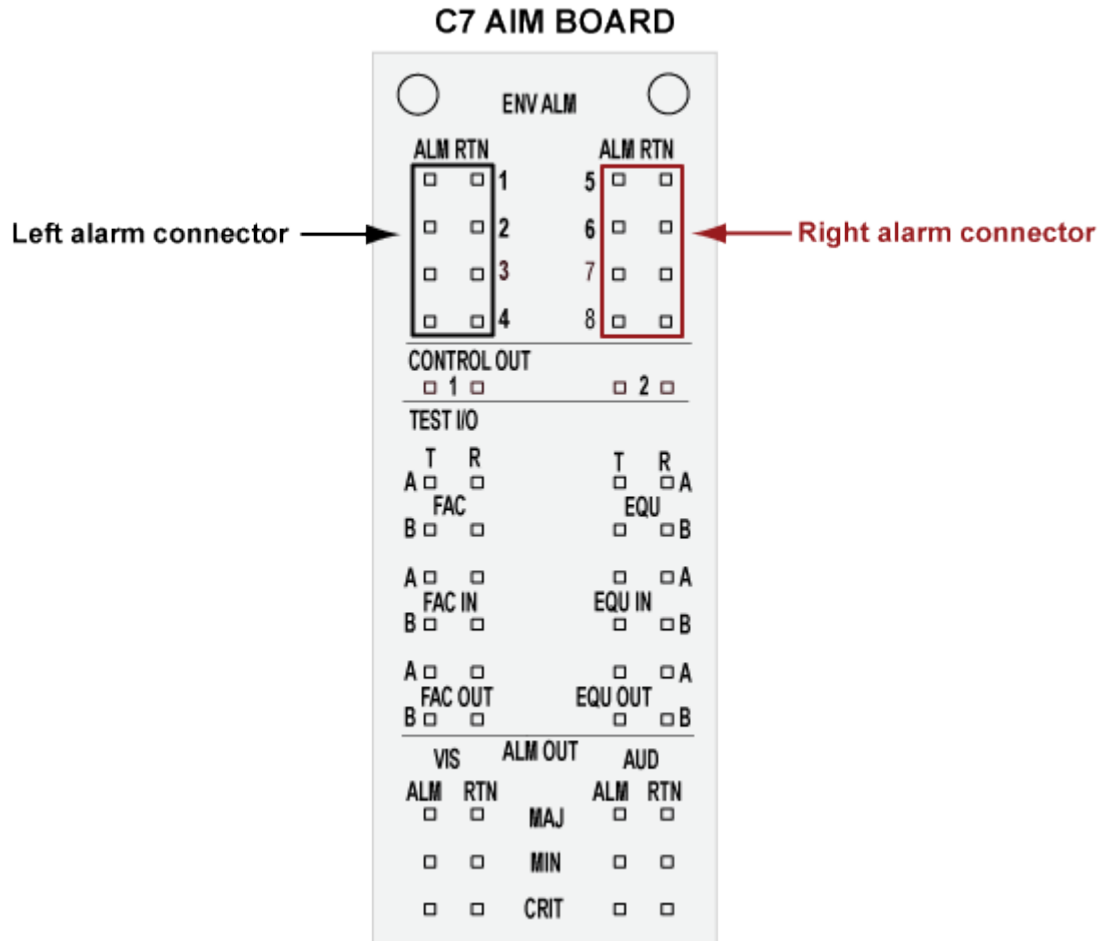

- Wire-wrap the alarm cable from the heat exchanger to the environmental alarm pins on the AIM board.

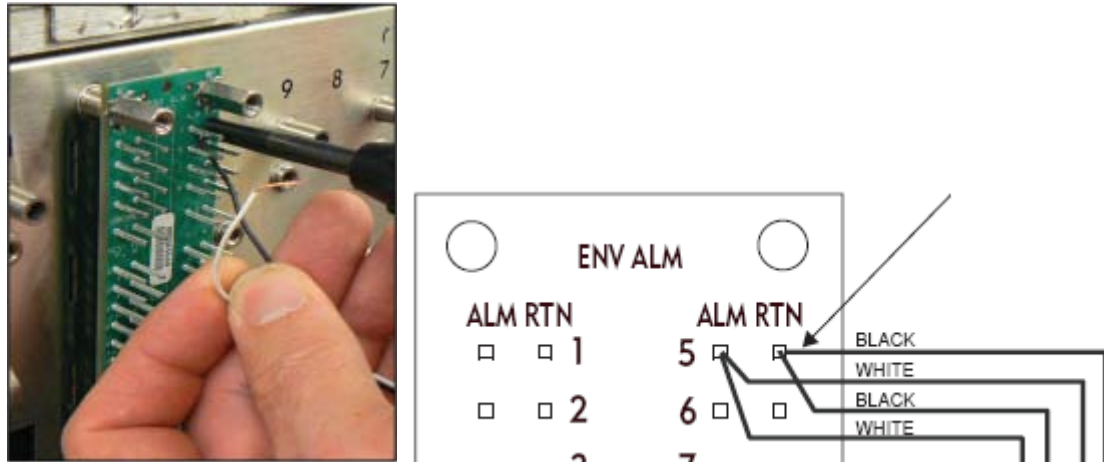

- c. Replace the right alarm connector cable over the wire wrapped alarm connection on the AIM board.
5. Use the supplied plastic cable clamps and tie wraps to dress and secure the power and alarm cables to the shelf.

Note: Ensure the cables clear the hinge and allow full movement of the door without binding.



Testing the Installed Heat Exchanger

This topic describes how to test operation of the newly-installed heat exchanger.

To test the installed heat exchanger

1. Ensure that all cables are properly connected and the 5 Amp GMT fuse is installed in the appropriate fuse position in the DC distribution.
2. Push the TEST button on the heat exchanger alarm/control box. Ensure the fans power-up and spin freely.

Note: If any noise or rubbing is observed, release the TEST button and call the Calix Technical Assistance Center for support.

3. With the fans spinning, test the airflow by placing a sheet of paper near the two inlets and observe the paper being pulled towards the inlets. The inlets are the upper ports on both the inside and outside of the heat exchanger.
4. Test the Alarm circuit by unplugging one of the fan power leads while the fans are ON.
5. Carefully close the cabinet doors ensuring that all equipment and cables are clear.

This completes installation of the heat exchanger kit. The cabinet is ready for regular operation.

Calix recommends monitoring the card temperatures for a few days to ensure the proper functioning of the units.